

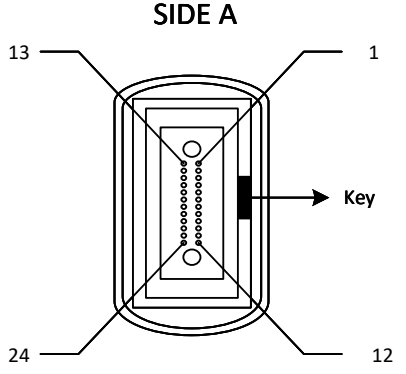

Fiber Configuration: Type U

Fiber no.	1	2	3	4	5	6	7	8	9	10	11	12
FC	Blue	Orange	Green	Brown	Grey	White	Red	Black	Yellow	Violet	Pink	Aqua
Fiber no.	13	14	15	16	17	18	19	20	21	22	23	24
FC	Blue	Orange	Green	Brown	Grey	White	Red	Black	Yellow	Violet	Pink	Aqua

Specification:

- 1.MTP Low Loss IL: $\leq 0.35\text{dB}$, Ultra low loss: $\leq 0.25\text{dB}$; FC Low loss: $\leq 0.25\text{dB}$
- 2.Return Loss: $\geq 65\text{dB}$
- 3.Operation Environment: $-40\sim+85^{\circ}\text{C}$
- 4.Storage Environment: $-40\sim+85^{\circ}\text{C}$



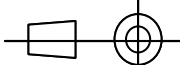

SHENZHEN OPTICO COMMUNICATION CO., LTD.

Model	24F MTPAPC Female-FC Fan-out Patchcord Type U SM G657A2 3.0mm Yellow LSZH CPR-Dca Cable					OP-24F-MTPFFCA-FP-SM-U			
FIRST ANGLE PROJECTION 	MATERIAL	UNIT	SCALE	SIZE	SHEET	DRAWN	XUELING W	DATE	2025.04.25
	LSZH	m	/	A4	1	CHECKED	Michael Liu	DATE	2025.04.25
						APPROVED	STEVEN Zhang	DATE	2025.04.25

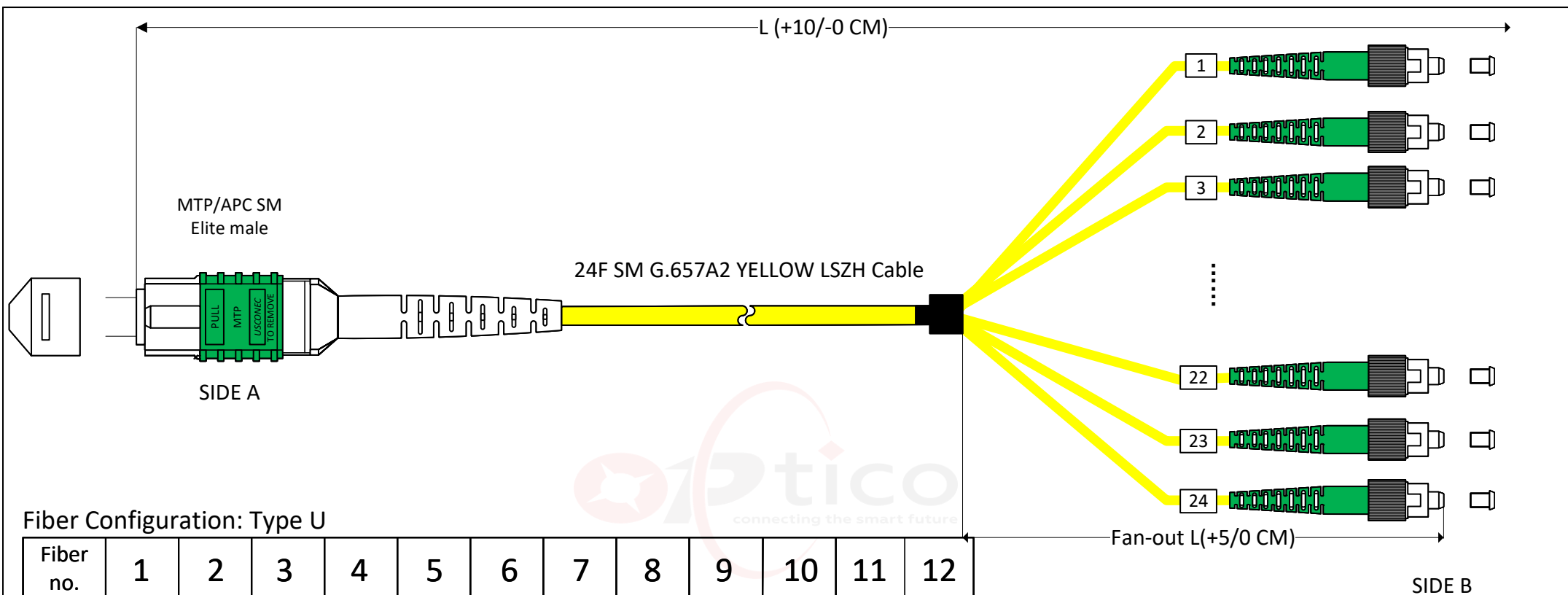

Fiber Configuration: Type U

Fiber no.	1	2	3	4	5	6	7	8	9	10	11	12
FC	Blue	Orange	Green	Brown	Grey	White	Red	Black	Yellow	Violet	Pink	Aqua
Fiber no.	13	14	15	16	17	18	19	20	21	22	23	24
FC	Blue	Orange	Green	Brown	Grey	White	Red	Black	Yellow	Violet	Pink	Aqua

SIDE A

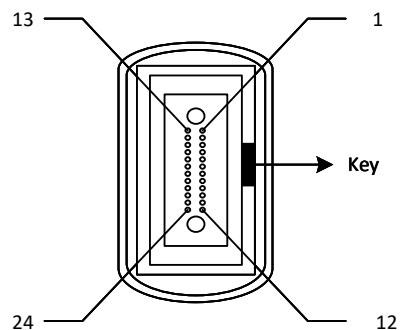

Specification:

- 1.MTP Low Loss IL: $\leq 0.35\text{dB}$, Ultra low loss: $\leq 0.25\text{dB}$; FC Low loss: $\leq 0.25\text{dB}$
- 2.Return Loss: $\geq 65\text{dB}$
- 3.Operation Environment: $-40\sim+85^{\circ}\text{C}$
- 4.Storage Environment: $-40\sim+85^{\circ}\text{C}$



SHENZHEN OPTICO COMMUNICATION CO., LTD.

Model	24F MTPAPC male-FC Fan-out Patchcord Type U SM G657A2 3.0mm Yellow LSZH CPR-Dca Cable					OP-24F-MTPMFC A-FP-SM-U			
FIRST ANGLE PROJECTION	MATERIAL	UNIT	SCALE	SIZE	SHEET	DRAWN	XUELING W	DATE	2025.04.25
	LSZH	m		A4	1	CHECKED	Michael Liu	DATE	2025.04.25
						APPROVED	STEVEN Zhang	DATE	2025.04.25

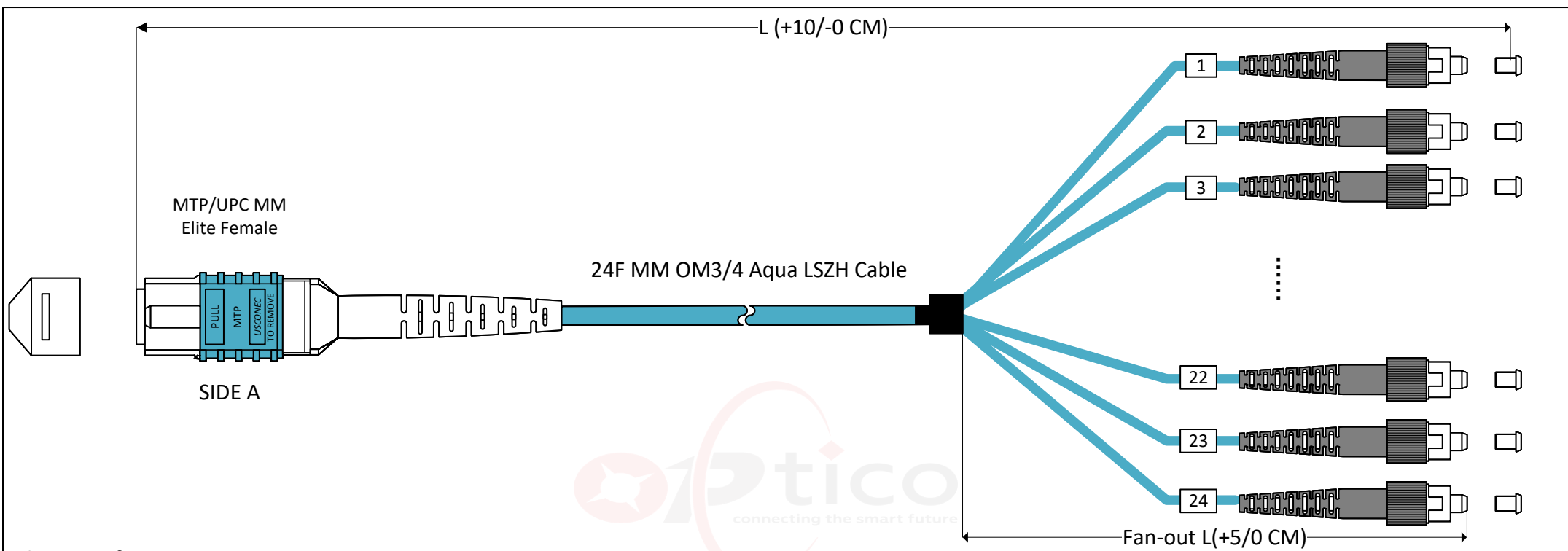



Fiber Configuration: Type U

Fiber no.	1	2	3	4	5	6	7	8	9	10	11	12
FC	Blue	Orange	Green	Brown	Grey	White	Red	Black	Yellow	Violet	Pink	Aqua
Fiber no.	13	14	15	16	17	18	19	20	21	22	23	24
FC	Blue	Orange	Green	Brown	Grey	White	Red	Black	Yellow	Violet	Pink	Aqua

Specification:

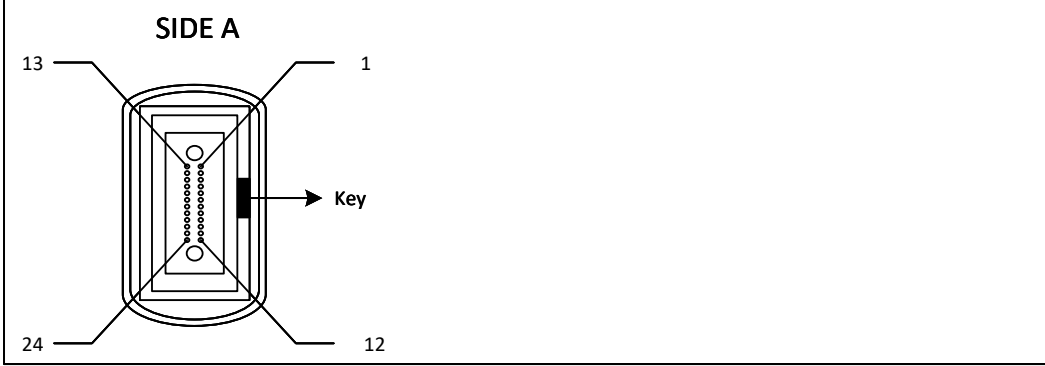
- 1.MTP Low Loss IL: $\leq 0.35\text{dB}$, Ultra low loss: $\leq 0.25\text{dB}$; FC Low loss: $\leq 0.25\text{dB}$
- 2.Return Loss: $\geq 35\text{dB}$
- 3.Operation Environment: $-40\sim+85^{\circ}\text{C}$
- 4.Storage Environment: $-40\sim+85^{\circ}\text{C}$



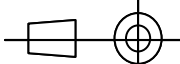

SHENZHEN OPTICO COMMUNICATION CO., LTD.

Model	24F MTPUPC Female-FC Fan-out Patchcord Type U OM3/4 3.0mm Aqua LSZH CPR-Dca Cable					OP-24F-MTPFFCU-FP-M3/4-U			
FIRST ANGLE PROJECTION 	MATERIAL	UNIT	SCALE	SIZE	SHEET	DRAWN	XUELING W	DATE	2025.04.25
	LSZH	m	/	A4	1	CHECKED	Michael Liu	DATE	2025.04.25
						APPROVED	STEVEN Zhang	DATE	2025.04.25

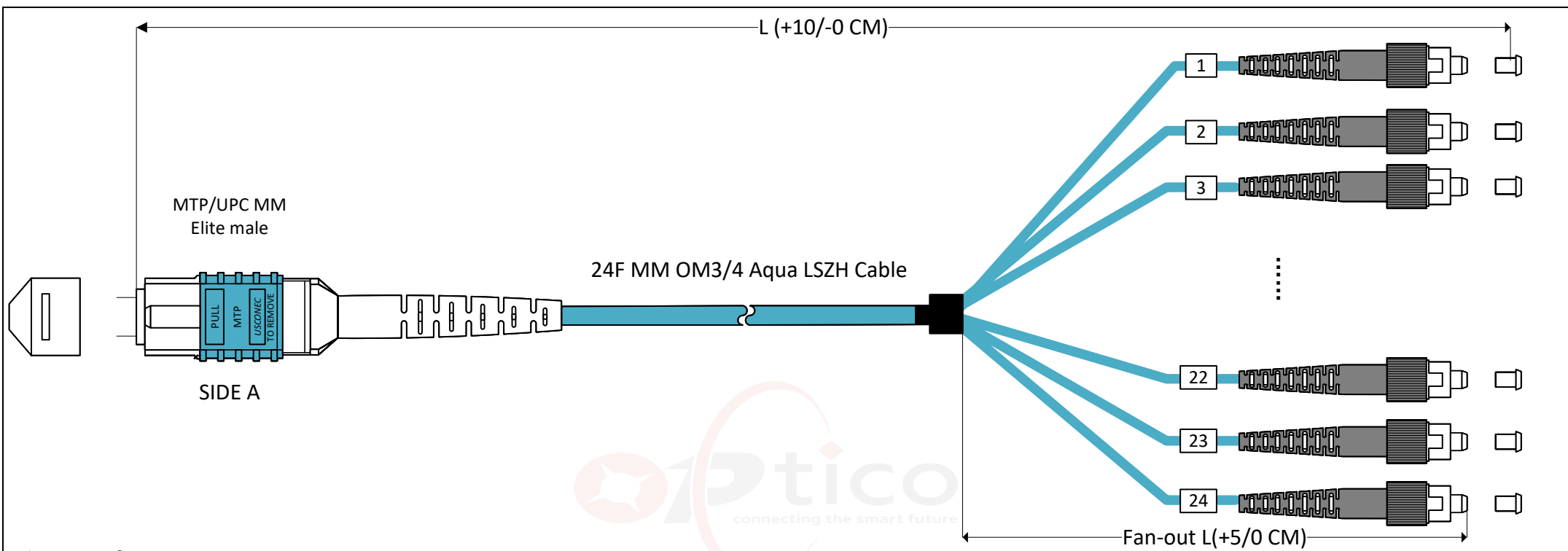

Fiber Configuration: Type U

Fiber no.	1	2	3	4	5	6	7	8	9	10	11	12
FC	Blue	Orange	Green	Brown	Grey	White	Red	Black	Yellow	Violet	Pink	Aqua
Fiber no.	13	14	15	16	17	18	19	20	21	22	23	24
FC	Blue	Orange	Green	Brown	Grey	White	Red	Black	Yellow	Violet	Pink	Aqua

Specification:

- 1.MTP Low Loss IL: $\leq 0.35\text{dB}$, Ultra low loss: $\leq 0.25\text{dB}$; FC Low loss: $\leq 0.25\text{dB}$
- 2.Return Loss: $\geq 35\text{dB}$
- 3.Operation Environment: $-40\sim+85^{\circ}\text{C}$
- 4.Storage Environment: $-40\sim+85^{\circ}\text{C}$

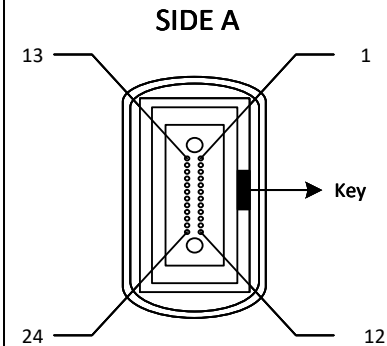

SHENZHEN OPTICO COMMUNICATION CO., LTD.

Model	24F MTPUPC male-FC Fan-out Patchcord Type U OM3/4 3.0mm Aqua LSZH CPR-Dca Cable					OP-24F-MTPMFCU-FP-M3/4-U			
FIRST ANGLE PROJECTION	MATERIAL	UNIT	SCALE	SIZE	SHEET	DRAWN	XUELING W	DATE	2025.04.25
	LSZH	m	/	A4	1	CHECKED	Michael Liu	DATE	2025.04.25
						APPROVED	STEVEN Zhang	DATE	2025.04.25

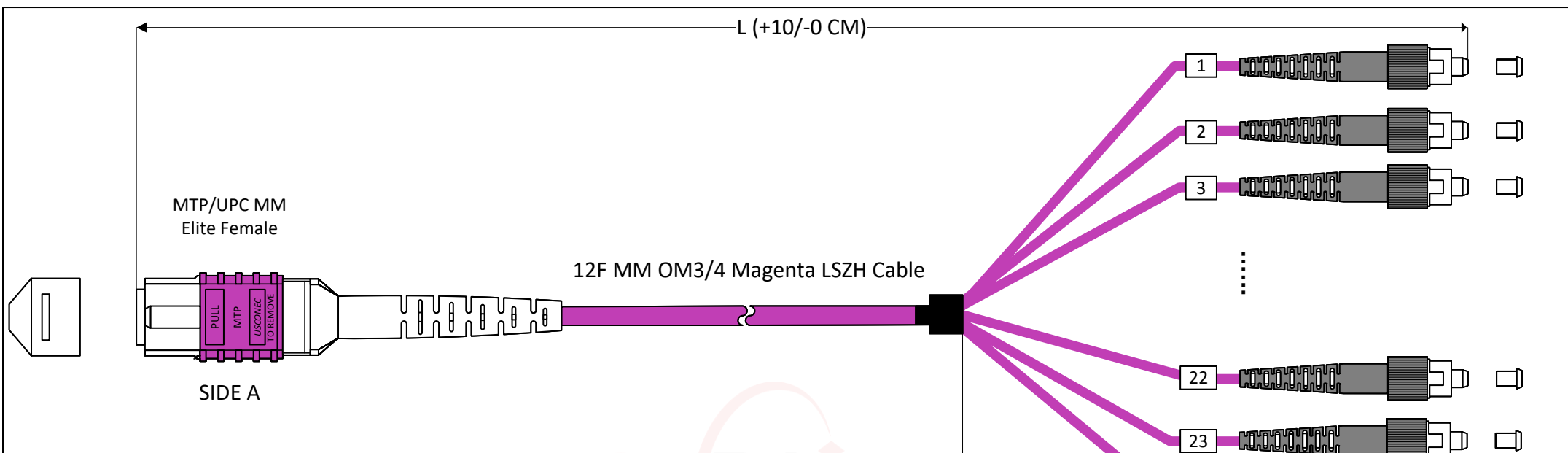

Fiber Configuration: Type U

Fiber no.	1	2	3	4	5	6	7	8	9	10	11	12
FC	Blue	Orange	Green	Brown	Grey	White	Red	Black	Yellow	Violet	Pink	Aqua
Fiber no.	13	14	15	16	17	18	19	20	21	22	23	24
FC	Blue	Orange	Green	Brown	Grey	White	Red	Black	Yellow	Violet	Pink	Aqua

Specification:

- 1.MTP Low Loss IL: $\leq 0.35\text{dB}$, Ultra low loss: $\leq 0.25\text{dB}$; FC Low loss: $\leq 0.25\text{dB}$
- 2.Return Loss: $\geq 35\text{dB}$
- 3.Operation Environment: $-40\sim+85^{\circ}\text{C}$
- 4.Storage Environment: $-40\sim+85^{\circ}\text{C}$

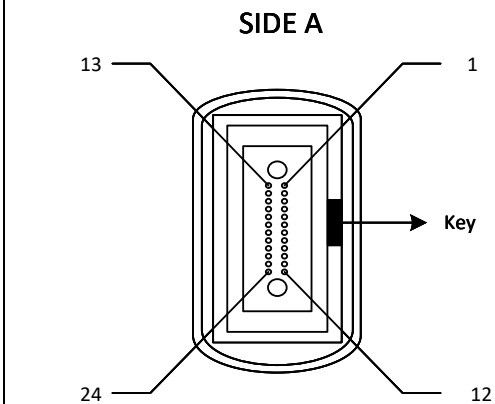

SHENZHEN OPTICO COMMUNICATION CO., LTD.

Model	24F MTPUPC Female-FC Fan-out Patchcord Type U OM3/4 3.0mm Magenta LSZH CPR-Dca Cable					OP-24F-MTPFFCU-FP-M3/4-U			
FIRST ANGLE PROJECTION	MATERIAL	UNIT	SCALE	SIZE	SHEET	DRAWN	XUELING W	DATE	2025.04.25
	LSZH	m		A4	1	CHECKED	Michael Liu	DATE	2025.04.25
						APPROVED	STEVEN Zhang	DATE	2025.04.25

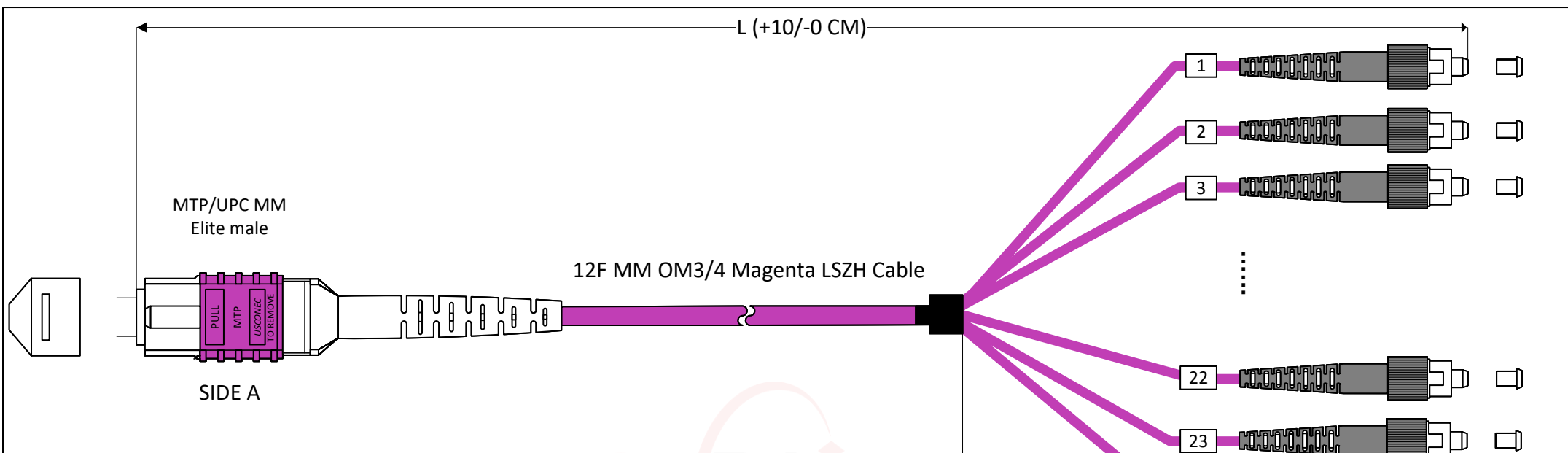

Fiber Configuration: Type U

Fiber no.	1	2	3	4	5	6	7	8	9	10	11	12
FC	Blue	Orange	Green	Brown	Grey	White	Red	Black	Yellow	Violet	Pink	Aqua
Fiber no.	13	14	15	16	17	18	19	20	21	22	23	24
FC	Blue	Orange	Green	Brown	Grey	White	Red	Black	Yellow	Violet	Pink	Aqua

Specification:

- 1.MTP Low Loss IL: $\leq 0.35\text{dB}$, Ultra low loss: $\leq 0.25\text{dB}$; FC Low loss: $\leq 0.25\text{dB}$
- 2.Return Loss: $\geq 35\text{dB}$
- 3.Operation Environment: $-40\sim+85^{\circ}\text{C}$
- 4.Storage Environment: $-40\sim+85^{\circ}\text{C}$

SIDE A

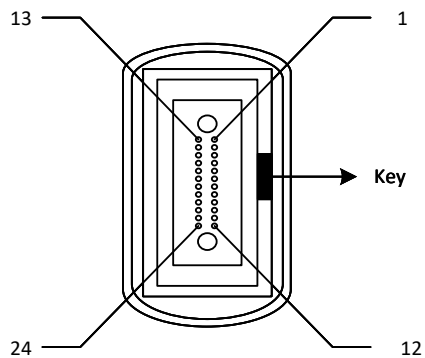

SHENZHEN OPTICO COMMUNICATION CO., LTD.

Model	24F MTPUPC Female-FC Fan-out Patchcord Type U OM3/4 3.0mm Magenta LSZH CPR-Dca Cable					OP-24F-MTPMFCU-FP- M3/4-U			
FIRST ANGLE PROJECTION 	MATERIAL	UNIT	SCALE	SIZE	SHEET	DRAWN	XUELING W	DATE	2025.04.25
	LSZH	m	/	A4	1	CHECKED	Michael Liu	DATE	2025.04.25
						APPROVED	STEVEN Zhang	DATE	2025.04.25

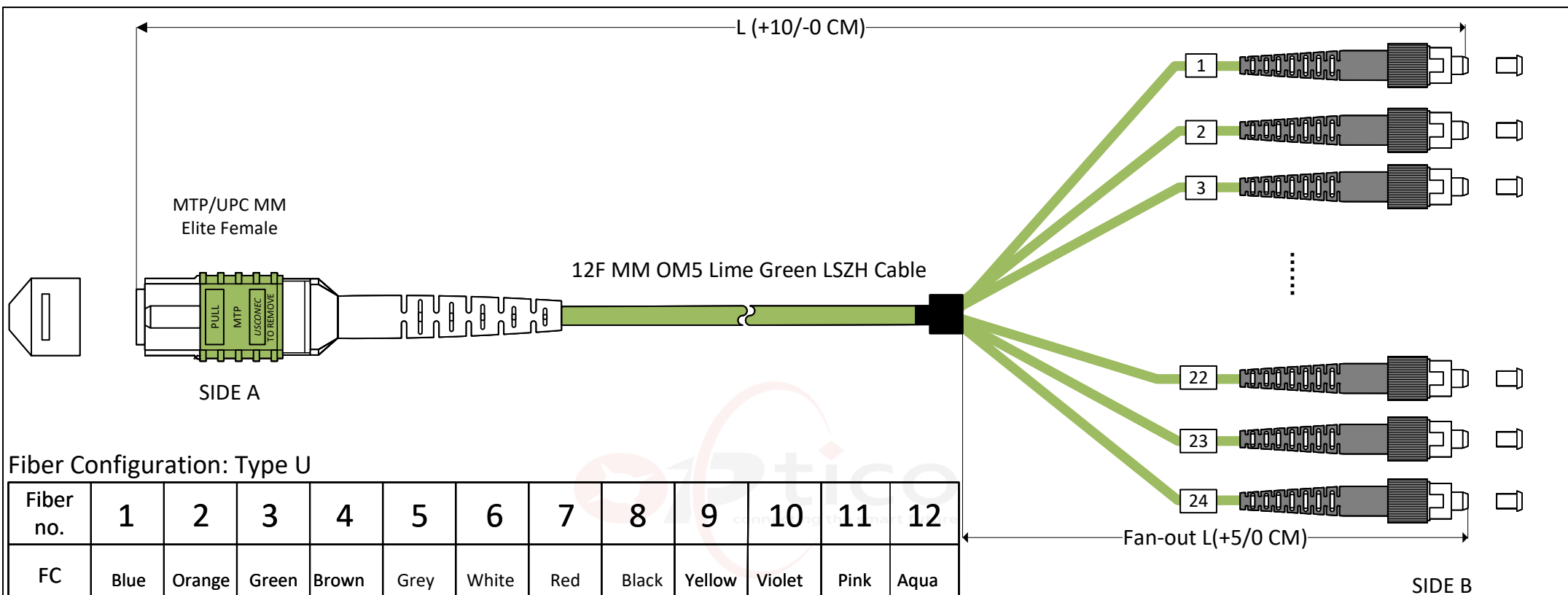

Fiber Configuration: Type U

Fiber no.	1	2	3	4	5	6	7	8	9	10	11	12
FC	Blue	Orange	Green	Brown	Grey	White	Red	Black	Yellow	Violet	Pink	Aqua
Fiber no.	13	14	15	16	17	18	19	20	21	22	23	24
FC	Blue	Orange	Green	Brown	Grey	White	Red	Black	Yellow	Violet	Pink	Aqua

Specification:

- 1.MTP Low Loss IL: $\leq 0.35\text{dB}$, Ultra low loss: $\leq 0.25\text{dB}$; FC Low loss: $\leq 0.25\text{dB}$
- 2.Return Loss: $\geq 35\text{dB}$
- 3.Operation Environment: $-40\sim+85^{\circ}\text{C}$
- 4.Storage Environment: $-40\sim+85^{\circ}\text{C}$

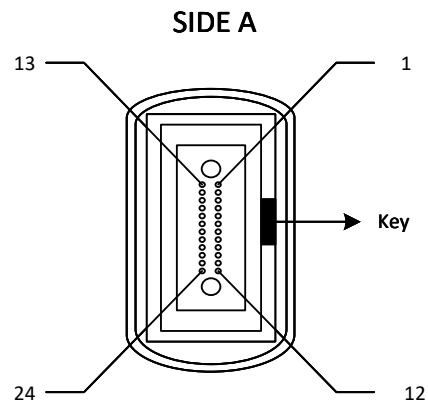

SHENZHEN OPTICO COMMUNICATION CO., LTD.

Model	24F MTPUPC Female-FC Fan-out Patchcord Type U OM5 3.0mm Lime Green LSZH CPR-Dca Cable					OP-24F-MTPFFCU-FP-M5-U			
FIRST ANGLE PROJECTION	MATERIAL	UNIT	SCALE	SIZE	SHEET	DRAWN	XUELING W	DATE	2025.04.25
	LSZH	m		A4	1	CHECKED	Michael Liu	DATE	2025.04.25
						APPROVED	STEVEN Zhang	DATE	2025.04.25

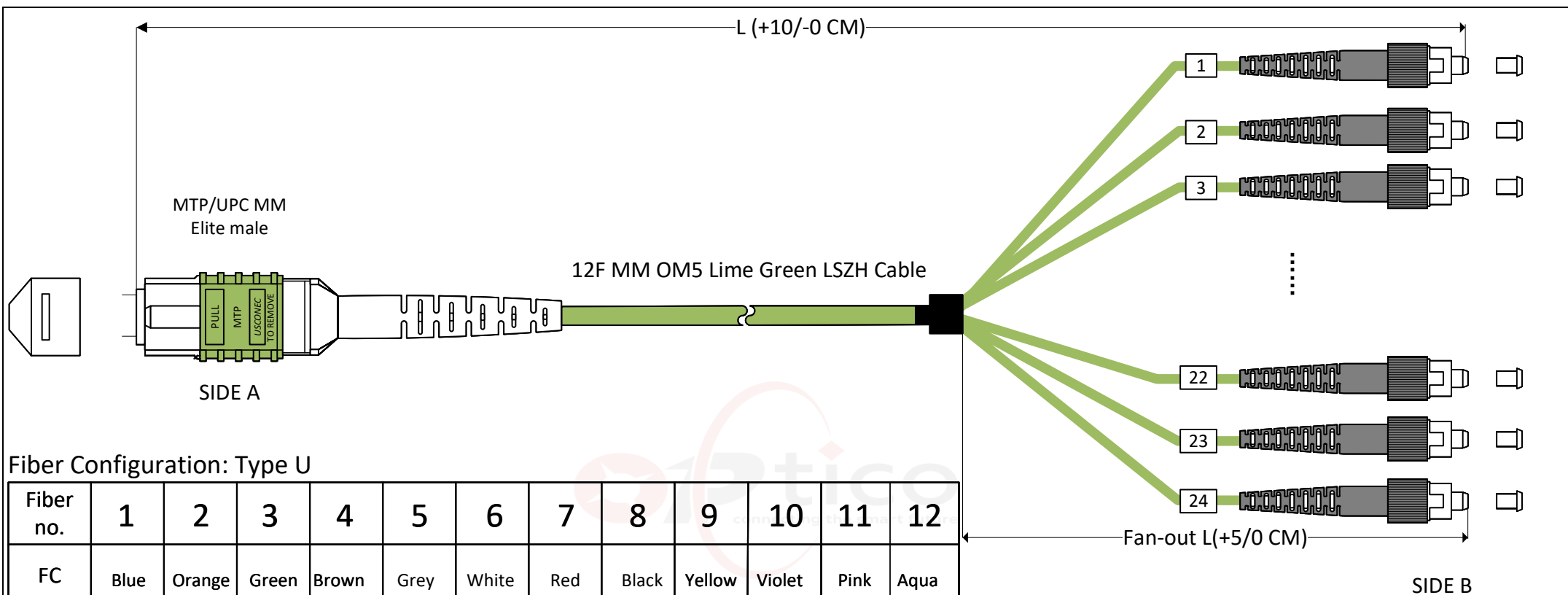



Fiber Configuration: Type U

Fiber no.	1	2	3	4	5	6	7	8	9	10	11	12
FC	Blue	Orange	Green	Brown	Grey	White	Red	Black	Yellow	Violet	Pink	Aqua
Fiber no.	13	14	15	16	17	18	19	20	21	22	23	24
FC	Blue	Orange	Green	Brown	Grey	White	Red	Black	Yellow	Violet	Pink	Aqua

Specification:

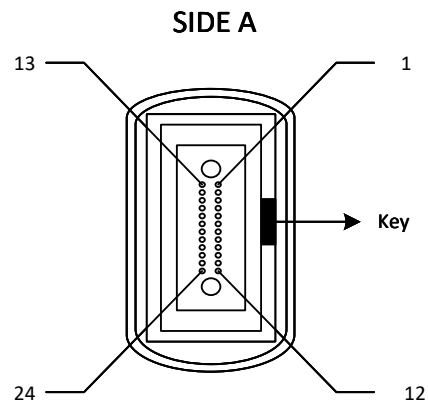
- 1.MTP Low Loss IL: $\leq 0.35\text{dB}$, Ultra low loss: $\leq 0.25\text{dB}$; FC Low loss: $\leq 0.25\text{dB}$
- 2.Return Loss: $\geq 35\text{dB}$
- 3.Operation Environment: $-40\sim+85^{\circ}\text{C}$
- 4.Storage Environment: $-40\sim+85^{\circ}\text{C}$



		SHENZHEN OPTICO COMMUNICATION CO., LTD.								
Model	24F MTPUPC Female-FC Fan-out Patchcord Type U OM5 3.0mm Lime Green LSZH CPR-Dca Cable						OP-24F-MTPMFCU-FP-M5-U			
FIRST ANGLE PROJECTION	MATERIAL	UNIT	SCALE	SIZE	SHEET	DRAWN	XUELING W	DATE	2025.04.25	
	LSZH	m		A4	1	CHECKED	Michael Liu	DATE	2025.04.25	
						APPROVED	STEVEN Zhang	DATE	2025.04.25	